

E2636

THIS PAGE LEFT BLANK INTENTIONALLY



**Endicott Research Group, Inc.**

2601 Wayne St., Endicott NY 13760

607-754-9187

Made in U.S.A.



**Endicott Research Group, Inc.**

2601 Wayne St., Endicott NY 13760

607-754-9187 Fax 607-754-9255

<http://www.ergpower.com>

## Specifications and Applications Information

11/07/01

Preliminary

The E2636 (E200II Series) dc to ac inverter is specifically designed to power the Optrex DMF50840 LCD display to a lower than nominal brightness level from a +5 volt dc source.

The E2636's small size, encapsulated package and low input power requirements (typically 1.8 watts) makes it the ideal power source for battery applications where small size, high efficiency and reliability are critical.

This standard inverter is designed to satisfy the most common cold-cathode lighting requirements for the DMF50840 display. Custom units, providing different inputs, outputs or package refinements are available.

### Connection Diagram

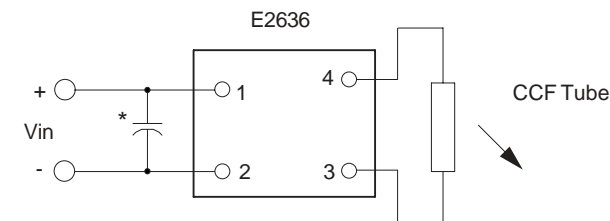

\* Input bypass capacitor may be required (10uf - 100uf)

E2636

Single Tube  
DC to AC Inverter

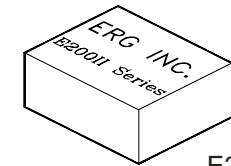

E200 Package

### Package Configuration

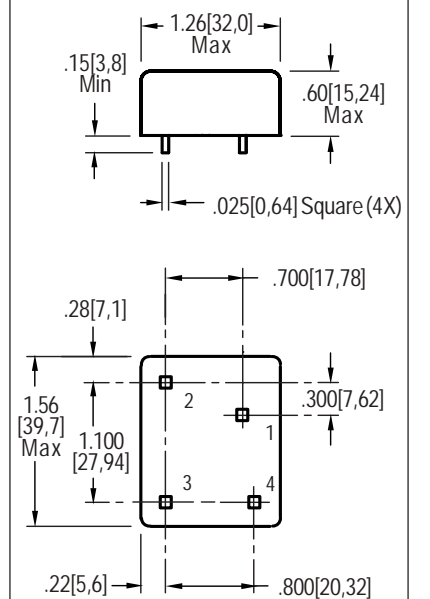

1. Vin(+)
2. Vin(-)
3. Vout(AC)
4. Vout(AC)

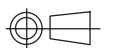

# E2636

## Absolute Maximum Ratings

Rating	Symbol	Value	Units
Input Voltage Range	Vin	-0.3 to +5.5	Vdc
Operating Temperature	To	-0 to +70	°C
Storage Temperature	Tstg	-40 to +85	°C

## Absolute Maximum Ratings

Rating	Symbol	Value	Units
Input Voltage	Vin	+2.5 to 5.5	Vdc

## Electrical Characteristics

Unless otherwise noted Vin = 5.00 Volts dc and Ta = 25°C

Characteristic	Symbol	Min	Typ	Max	Units
Input Current	Iin	-	.36	.42	Adc
Operating Frequency	Fo	27	32	37	KHz
Minimum Output Voltage	Vout (min)	1100	-	-	Vrms
Efficiency	-	-	81	-	%
Output Current	Iout	-	4.3	-	marms
Output Voltage (When powering a load simulating the referenced display)	Vout	-	340	-	Vrms
Pin3 Input Current Requirement	-	-	9	-	madc

After tube has been allowed to warm-up for 5 minutes  
External Disable Circuit shown on page 3.

Specifications subject to change without notice.



Endicott Research Group, Inc.

## Typical Performance Curves

# E2636

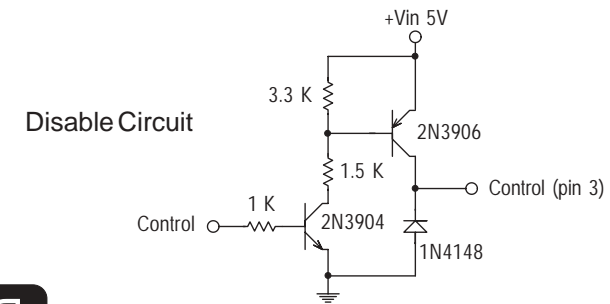
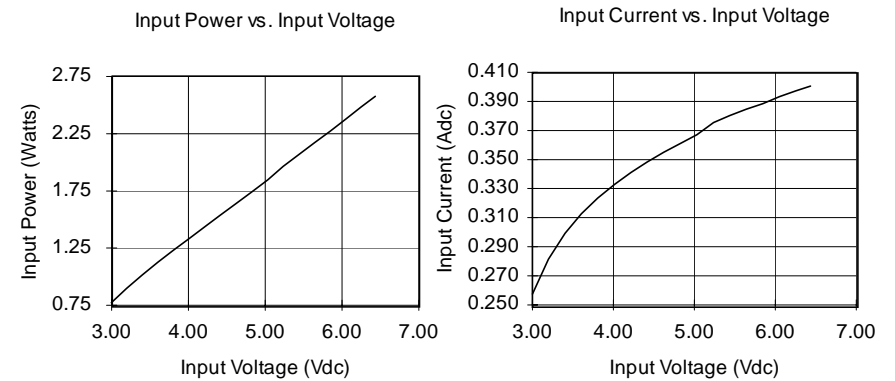
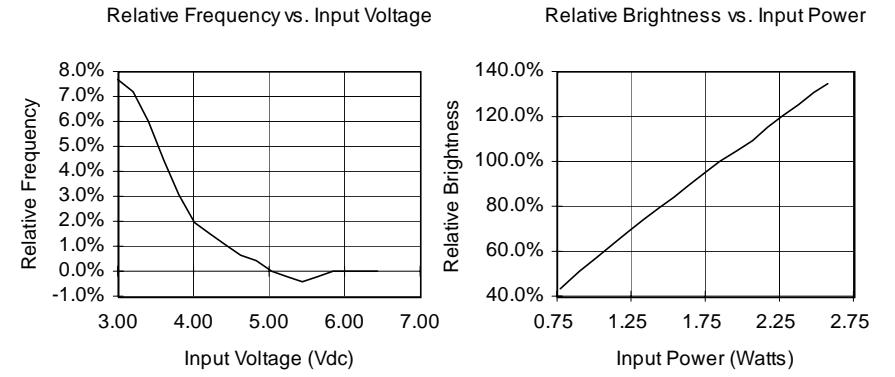

Endicott Research Group, Inc.