

## Smart Force™ Drop-In Replacement Series

The new DR Series provides LED driver package configurations that are footprint-compatible to their existing CCFL inverter designs. This new series of LED driver boards is designed in the same form factor as ERG DC-AC inverters already in the field. These drop-in replacements allow for a fast, easy upgrade to LED lighting without re-designing or re-tooling the mounting hardware. The LED drivers are pin-for-pin compatible with the inverters and have the same length and width dimensions as their counterparts as well as matching mounting holes. And, like the inverters they have been designed to replace, all ERG LED drivers are designed, manufactured, and supported in the USA.

The same way every customer's CCFL inverter is different, every Drop-In Replacement LED Driver is going to be different as well. Please contact your Sales Representative to find out about the DR-Series part that's right for your application.

# SMART FORCE™ DROP-IN REPLACEMENT SERIES

## GENERAL DIMENSIONS GUIDE

### DR-8M

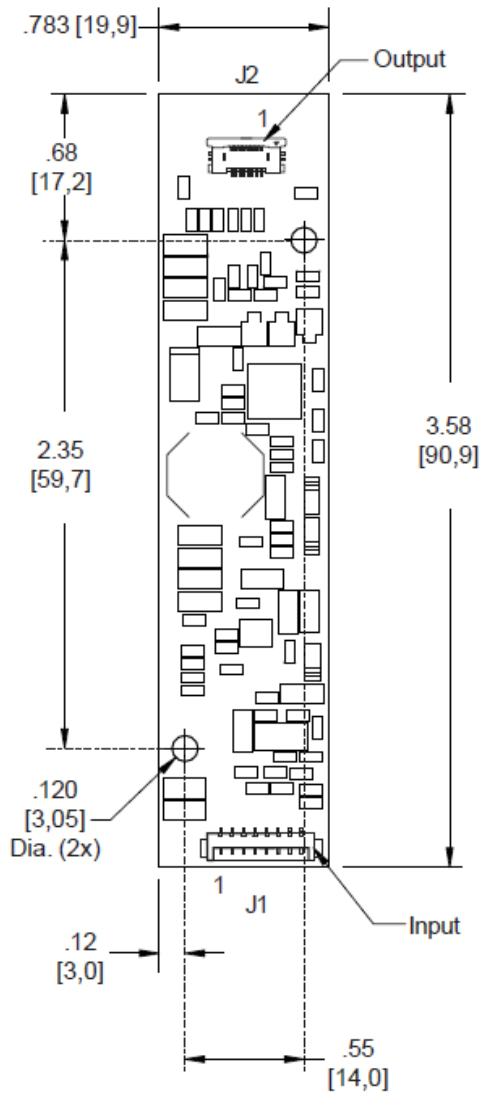

### DR-8MAD

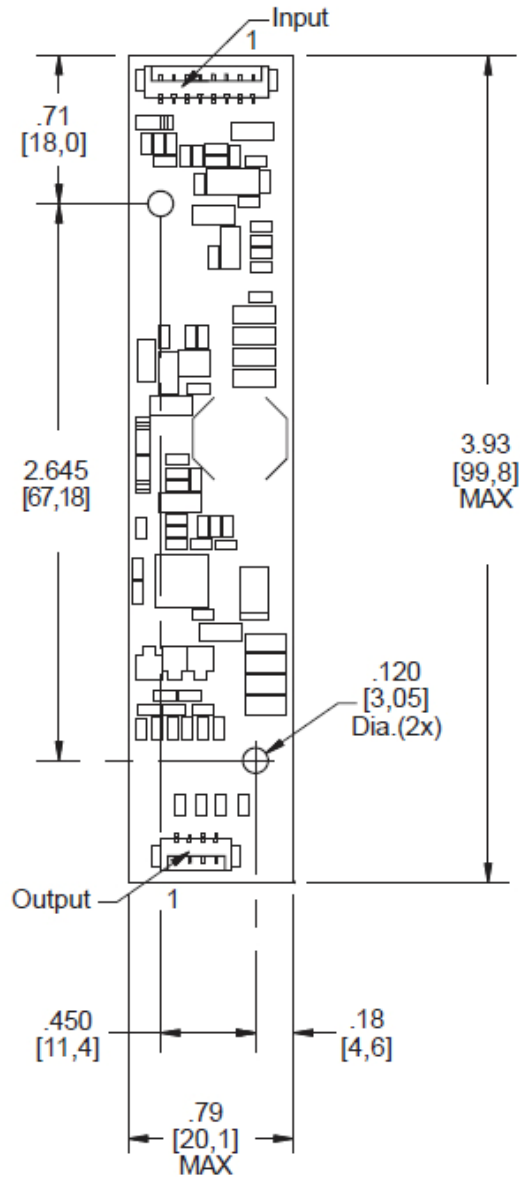

### DR-LD

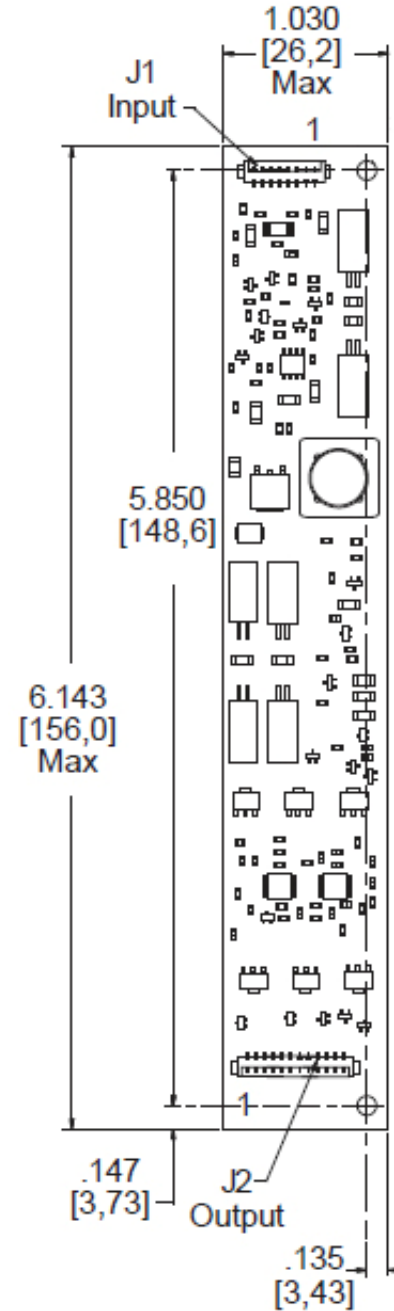

### DR-K

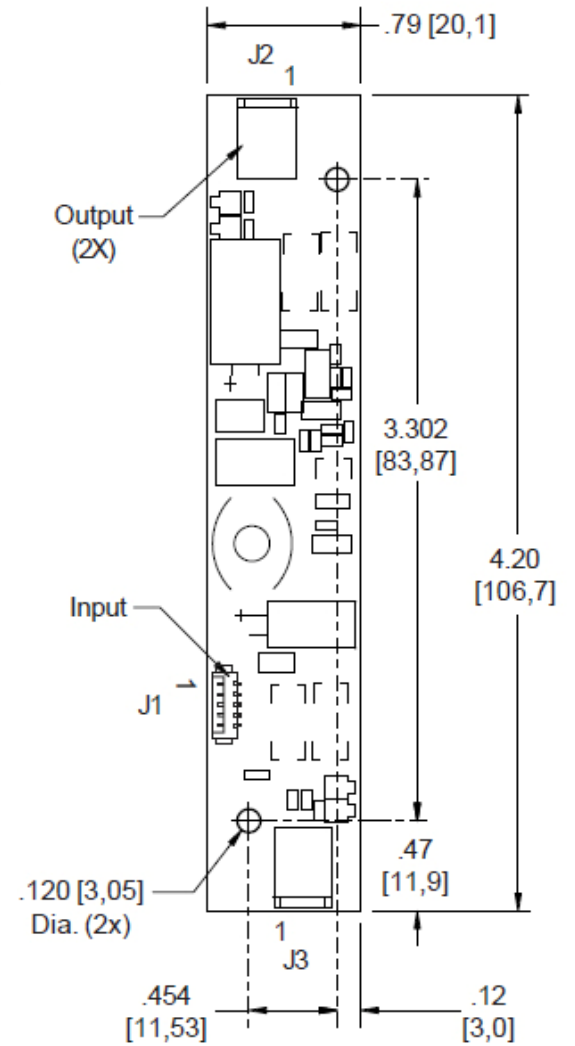

# SMART FORCE™ DROP-IN REPLACEMENT SERIES

## GENERAL DIMENSIONS GUIDE

### DR-DMAD

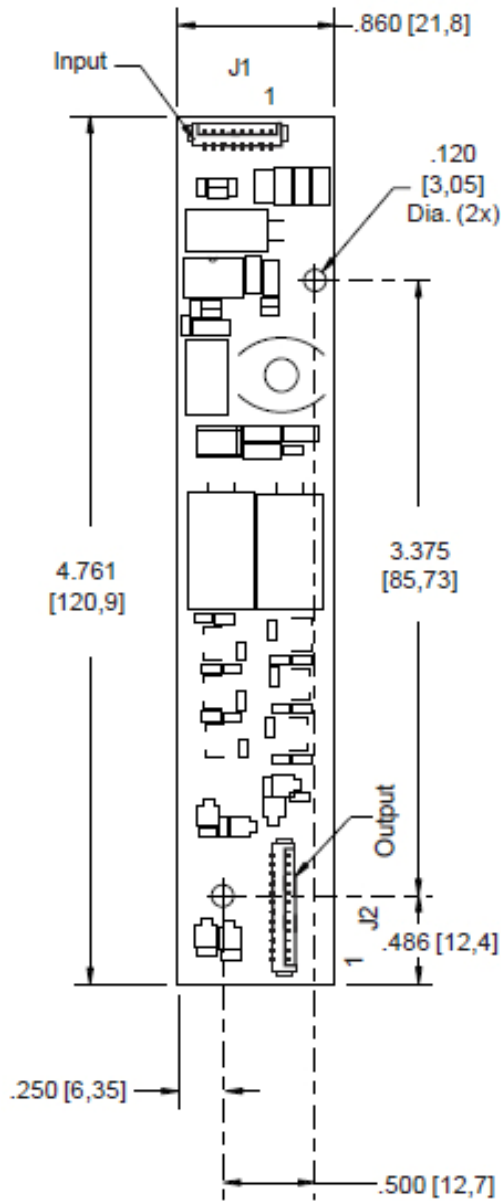

### DR-DMC

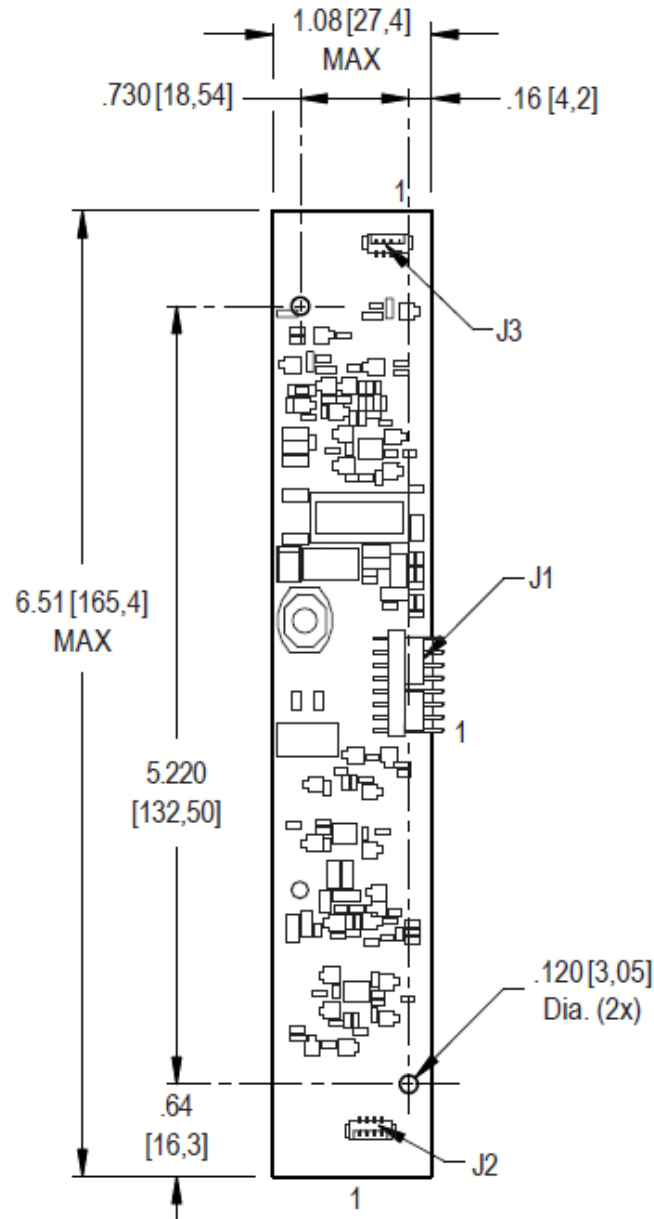

### DR-DMD

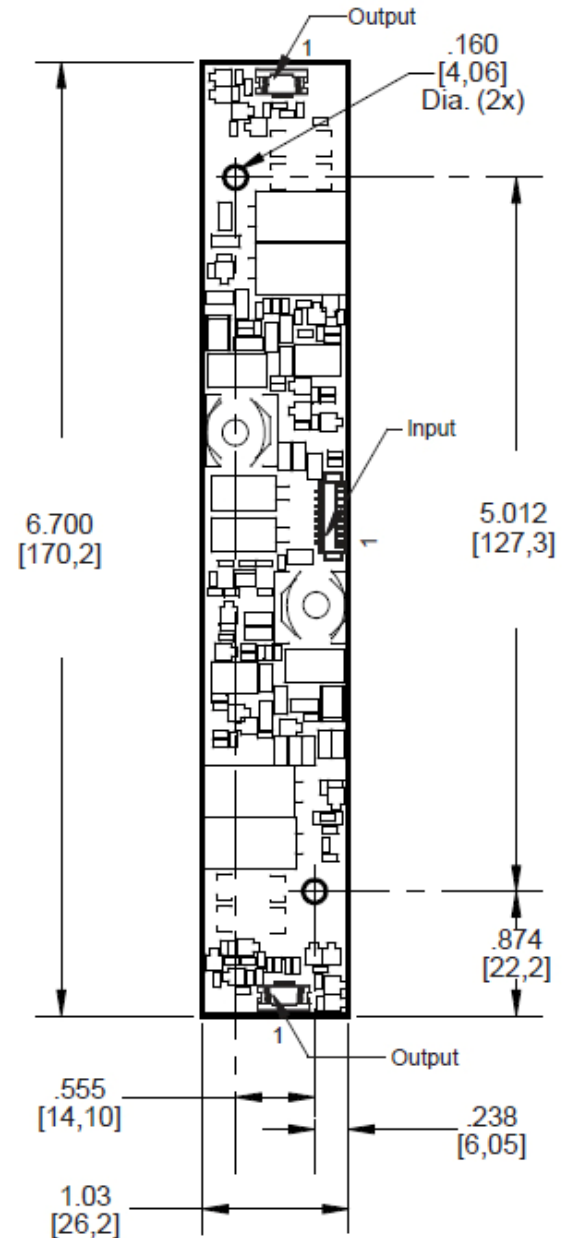

## SMART FORCE™ DROP-IN REPLACEMENT SERIES

- HIGH EFFICIENCY LED DRIVERS
- 10mm HEIGHT
- UP TO 8 DISCRETE CHANNELS (ONLY ON SPECIFIC CONFIGURATIONS)
- EXTERNAL & ONBOARD DIMMING AVAILABLE
- FFC / FPC COMPATIBLE
- OEM LED PANEL COMPATIBLE
- DESIGNED, MANUFACTURED, AND SUPPORTED IN THE USA
- ONE-YEAR WARRANTY

